

THESE DRAWINGS AND SPECIFICATIONS ARE THE PROPERTY OF JAMES B. LANSING SOUND, INC. THEY ARE ISSUED IN STRICT CONFIDENCE AND SHALL NOT BE REPRODUCED, COPIED, OR USED AS THE BASIS FOR MANUFACTURE OR SALE OF APPARATUS WITHOUT WRITTEN PERMISSION.

REVISIONS						
CHG	LTR	DESCRIPTION	DRFT	CHK	DATE	APPR
N-0330	A	REL FOR PRODUCTION	<i>Blum</i>	<i>Blum</i>	7-18-53	<i>Blum</i>
454G	B	ADD JUMPER WIRES TO S1	<i>Blum</i>	<i>ajj</i>	7-16-57	<i>Blum</i>

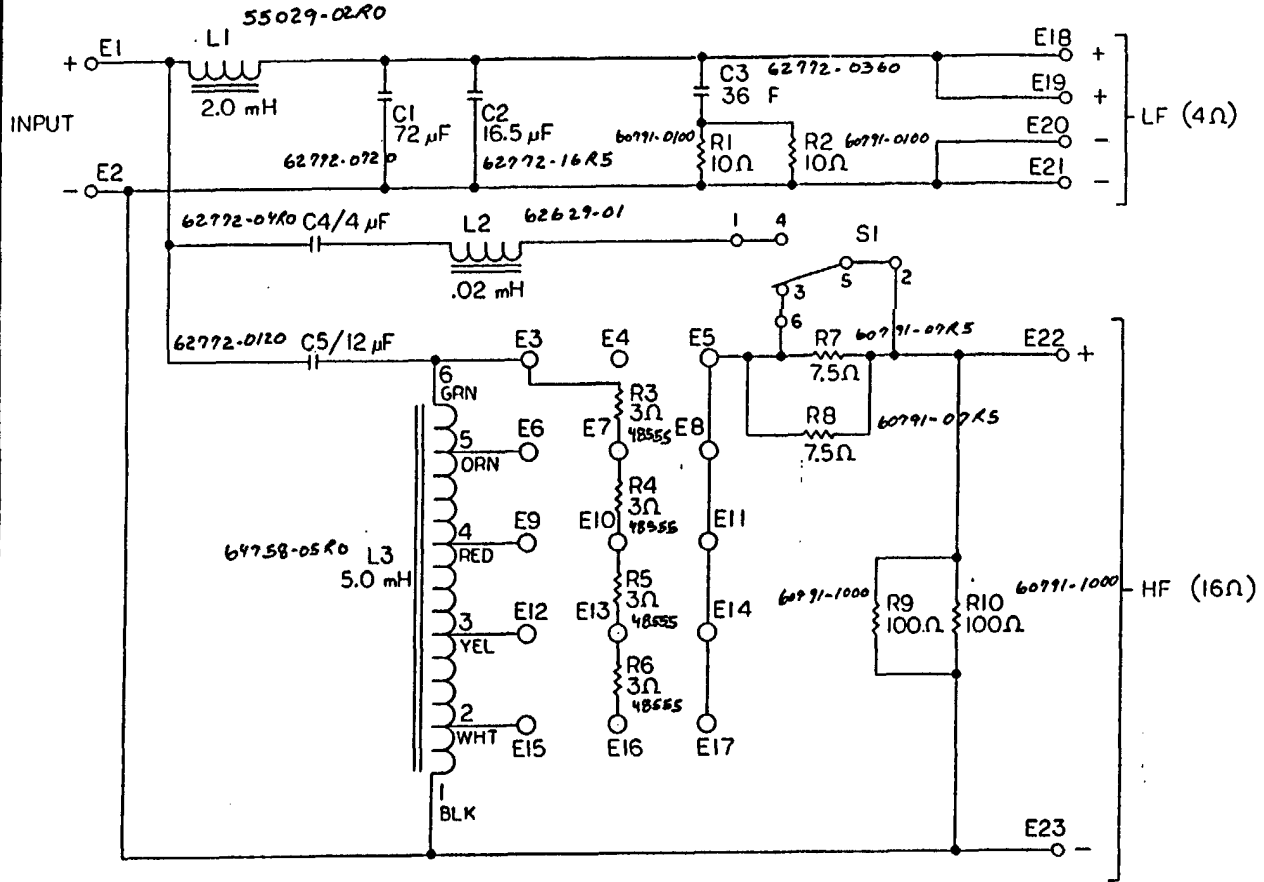

N31601

64754-01

NOTES: (UNLESS OTHERWISE SPECIFIED)

ITEM	PART NO.	DESCRIPTION	QTY	REMARKS
BILL OF MATERIAL				
UNLESS OTHERWISE SPECIFIED DIMENSIONS ARE IN INCHES GREAT SHARP EDGES .015 INCH		MATERIAL	DRAWN 6-22-53 <i>Blum</i>	JAMES B. LANSING SOUND, INC. A Harman International Company Northridge, California 91329, U.S.A.
TOLERANCES (UNLESS OTHERWISE SPECIFIED)		FINISH	CHECKED 6-30-53 <i>Blum</i>	
X.XXX ± .005 INCH		MODELS USED ON	DESIGN	TITLE
X.XX ± .010 INCH				SCHMATIC, 3160
X.X ± .070 INCH				SIZE
FRACTIONAL DIMENSIONS: ± 1/32				C 64754-01
ALL DIMENSIONS ARE FINISHED DIMENSIONS DO NOT SCALE DRAWING				REV B
				SCALE NONE
				SHEET 1 OF 1

Professional Series Instruction Manual

Frequency Dividing Networks

3105

3120A

3110A

3160

3115A



Specifications

Model	Crossover Frequency	Power Capacity Continuous Program ¹	Continuous Pink Noise ²	Impedance Low Frequency	High Frequency	High Frequency Gain (Attenuation)	High Frequency Boost
3105 ³	7000 Hz	70 watts	35 watts	16 ohms	8 ohms	Continuously Variable	N/A
3110A	800 Hz	300 watts	150 watts	8 ohms	16 ohms	6-8-10 dB, Switch	Minimum, Medium, Maximum, Switch
3115A	500 Hz	300 watts	150 watts	8 ohms	16 ohms	6-8-10 dB, Switch	Minimum, Medium, Maximum, Switch
3120A	1250 Hz	300 watts	150 watts	8 ohms	16 ohms	6-8-10 dB, Switch	Minimum, Medium, Maximum, Switch
3160	500 Hz	600 watts	300 watts	4 ohms	16 ohms	0-2-4-6-8 dB, Strap	In (Maximum), Out (Minimum), Switch

1. Continuous program power capacity is defined as 3 dB greater than continuous pink noise power.

2. Continuous pink noise power rating is based on a test signal of filtered random noise conforming to international standard IEC 268-5 (pink noise with 12 dB per octave rolloff below 40 Hz and above 5,000 Hz with a peak to average ratio of 6 dB), two hours duration.

3. The 3105 is optimized for a single 2402H, 2404H, or 2405H tweeter installed in a system with any 16 ohm JBL compression driver.

Introduction

JBL Professional Series high level passive frequency dividing networks are precision devices made with highest quality components throughout: non-inductive, non-polarized capacitors having high AC current capacity, built expressly for use in dividing networks; individually calibrated low-loss inductors; and heavy duty switches and resistors.

These networks have 12 dB per octave parallel L-C circuits. Additional conjugate elements are used to cancel out the inductive reactance of the low frequency loudspeaker. Since the 3105 crossover above 5 kHz, additional conjugates are not needed.

The 3105, 3110A, 3115A, and 3120A are general application networks. The 3160 is a high power unit designed primarily for theater, auditorium, or reinforcement applications.

The 3105 is optimized for any JBL 16 ohm compression driver with a single 2402H, 2404H, or 2405H tweeter.

Applications

JBL frequency dividing networks can be used with many different combinations of drivers. The choice of network should be made on the basis of desired crossover frequency, power handling capacity, and impedance of both the low

and high frequency drivers.

Matching the impedance of the drivers to the network is highly important, because the specified crossover point of the network is dependent upon correct driver impedances, as shown in Figure 1.

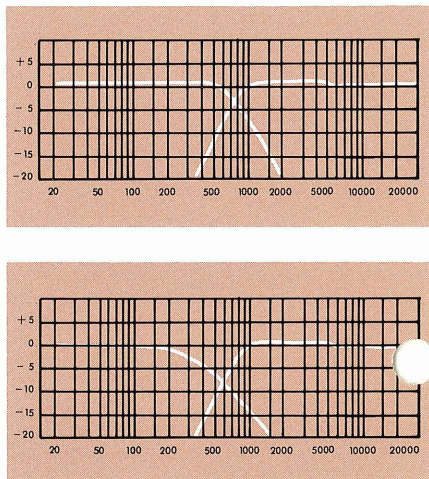

Figure 1. Properly and Improperly Matched Driver/Network Combinations (LF Driver impedance lower than required by network)

Selection of the network is based on the acoustical performance characteristics, acoustic loading, and properly matched impedances. JBL networks and drivers are designed to work together. Some drivers have actual impedances in their crossover regions which differ enough from the rated

impedance to create mismatches with JBL networks, and their response can be quite different from what might otherwise be predicted.

It is not always possible to develop proper network load impedances with series and/or parallel driver interconnections. In such circumstances, the use of the JBL 9375 autotransformer between the network and drivers can be helpful in developing proper load impedances.

In some applications, connection of more than one network to the output of an amplifier may be required. Autotransformers can be used for this application if the amplifier does not have the proper output impedances to match the network combination.

Power Capacity

JBL rates power handling capacity on the basis of continuous program, which is defined as 3 dB greater than the continuous rating. The continuous program rating is a conservative expression of the ability of the network and associated transducers to handle normal speech and music program material.

Continuous pink noise power ratings are based on a test signal of filtered random noise conforming to international standard IEC 268-5 (pink noise with -12 dB per octave rolloff below 40 Hz and above $5,000$ Hz with a peak to average ratio of 6 dB), two hours duration.

Installation

Mounting

General Application—General application networks can be mounted within a panel cutout or used as freestanding units. The mounting flange is fitted with a white vinyl gasket to maintain an air tight seal when the network is mounted in an enclosure panel, and is drilled for four 4 mm (#6) screws. A template is provided for the mounting cutout.

If the network is mounted in a low

frequency enclosure, which is the most common usage, the cutout must be accurate within the specified tolerances, and the gasket must be properly positioned on the mounting flange. Mounting screws should be tightened just enough to prevent air leaks which would result in degradation of low frequency performance or spurious noises.

High Power—The high power networks are designed for surface mounting. The flange is drilled for six 4 mm (#6) screws; a mounting template is provided. The network case is 154 mm (6 in) high. Allow sufficient clearance above the case for cover removal, which will be required when making wiring connections or setting high frequency attenuation. Note the four 22 mm (0.875 in) holes in the container sides for wiring convenience.

Connection

JBL networks and transducers are designed so that if the red terminal of each transducer is connected to the appropriate high terminal on the network (as shown in Figs. 2, 3 and 4) the system will be electrically in phase and diaphragm movements will be consistent. However, this arrangement may not result in proper acoustical phasing.

The connection resulting in proper acoustical phasing of any combination of components is difficult to determine in advance of assembly. Proper acoustical phasing of low and high frequency transducers will be that electrical phasing which produces maximum acoustic output through the crossover region. In general, if the diaphragms of the various transducers are in the same physical plane or arc, in-phase electrical connection will probably result in proper acoustical phasing. If the diaphragms are not in the same plane or arc, proper phasing should be determined experimentally, based on analysis of pink noise or subjective evaluation of program material.

For network connections up to 15 m (50 ft), 1.3 mm (#16 AWG) insulated wire is the minimum size recommended. Heavier gauge wire is recommended for greater distances: 1.6 mm (#14 AWG) from 15 m to 30 m (50 ft to 100 ft) and 2 mm (#12 AWG) from 30 m to 60 m (100 ft to 200 ft).

Important: When connecting or disconnecting networks or transducers, the amplifier must be turned off. Making connections while the amplifier is operating could seriously damage the network or loudspeakers, and void the warranties.

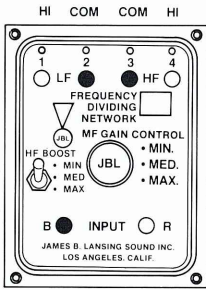

Figure 2. General Application Network Connection

Connections to general application networks are made at spring-loaded terminals. Press down on the terminals and insert the wires. Do not twist the terminals. Note that the wire holes do not go completely through these terminals. The small holes above the terminals allow for passage of the transducer wires from within enclosures.

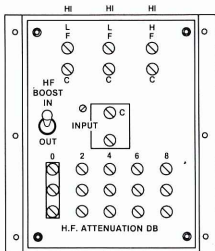

Figure 3. High Power Network Connection

Connections to the high power networks are made at screw terminals located under the top cover plate. Note that there are four common terminals, designated "C." These terminals are connected internally. The two LF high terminals are also internally connected, for convenience in wiring parallel low frequency transducers.

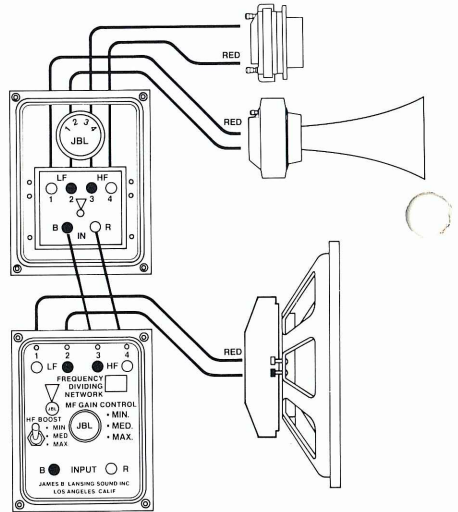

Figure 4. Three-Way System Connection

The connections shown for the components of a three-way system will result in correct electrical phasing. If the component voice coils, however, are not in the same plane or arc, proper acoustical phasing should be determined experimentally. Note that the attenuator of the mid-frequency network will vary the acoustic outputs of both midrange and high frequency drivers simultaneously.

Theater Systems Network Connections

Connections between JBL networks and theater sound systems follow the general scheme of those networks previously described. Specific wiring instructions are shown in Figs. 5, 6, and 7. Note: When wiring 4676B-1 and 4676B-2 theater systems, only 1.6 mm (#14 AWG) or larger wire should be used.

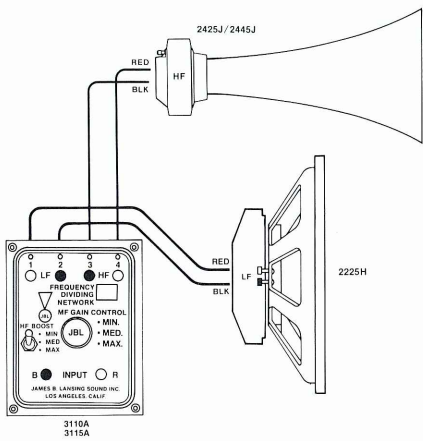

Figure 5. 4671/4673/4672A/4674A Theater System Connection

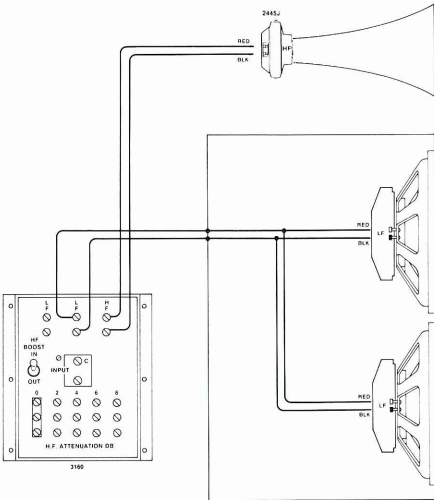

Figure 6. 4670B/4675A/4676B-1 Theater System Connection

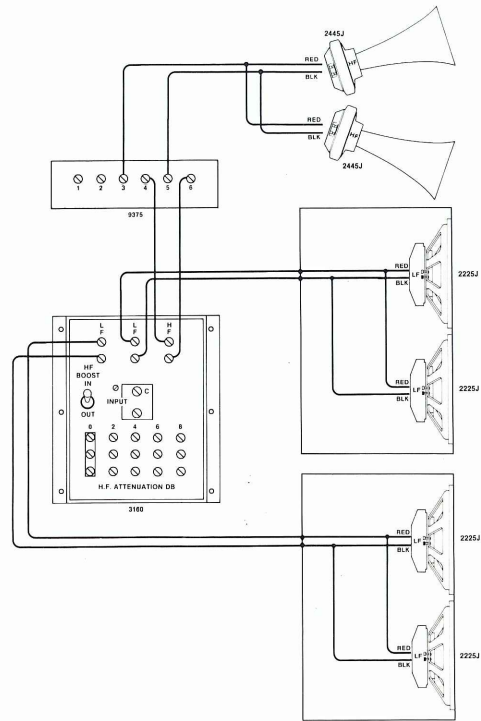

Figure 7. 4676B-2 Theater System Connection

Adjustment of HF Gain (Attenuation)

All networks are provided with a means for obtaining high frequency shelving. High power networks utilize a strapping bar across screw terminals labeled with the amount of attenuation achieved. The rotational controls used in general application networks are designed so that maximum high frequency output is achieved with the knob rotated fully clockwise. The 3105 is fitted with a continuously variable L-pad; the attenuation steps of the other controls are given in Table 1.

When connecting multiple drivers to a network, it may be necessary to separately adjust the acoustic output of individual drivers or groups of drivers. L-pads of the proper impedance and power handling capacity can be inserted in any leg of the system requiring attenuation in addition to that provided by the network. However, the total reflected impedance of all branches must match the network output impedance.

Table 1. Attenuation of Network Step Controls

Model	Gain Control Setting		
	Min	Med	Max
3110A	10 dB	8 dB	6 dB
3115A	10 dB	8 dB	6 dB
3120A	10 dB	8 dB	6 dB

Adjustment of HF Boost

The 3110A, 3115A, and 3120A have three-position high frequency boost switches, and the 3160 has a two position switch. These allow for adjustment of the high frequency range relative to the mid frequency level set by the gain or attenuation control. Since these are passive networks, the amount of boost and the turnover frequency will depend on the gain or attenuation level.

The amount of boost used will depend on the type of high frequency horns used and the dictates of the particular application. For flat axial response from radial or exponential horn designs, little or no boost will be required. For flat axial response from constant directivity designs, which will also produce flat power response, maximum boost may be required. The ultimate judgement should be made by ear, with the aid of real-time analysis or other measurement equipment if available.

It should be understood that the HF boost actually delivers more power to the compression driver at the high frequencies. Care should be exercised in high power applications to see that the thermal limits of the driver are not exceeded.

Note: Frequency dividing networks are not protective devices—their function is to divide the audio spectrum among the transducers. The power handling capacity of the high frequency transducers, therefore, should be great enough so that they will not be damaged by the amplifier when the network is set for maximum output.

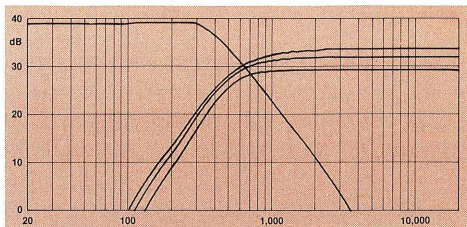

3115A 500 Hz Network

High frequency gain at minimum, medium, and maximum. High frequency boost at minimum.

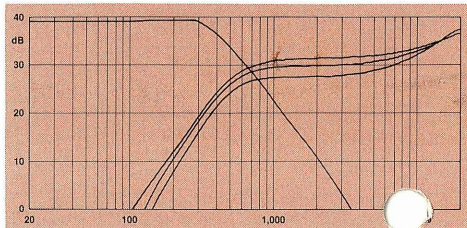

3115A 500 Hz Network

High frequency gain at minimum, medium, and maximum. High frequency boost at medium.

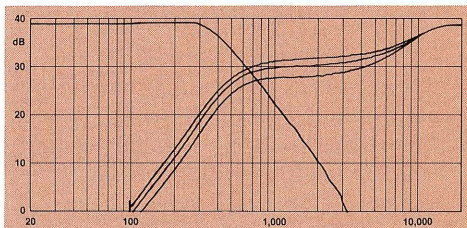

3115A 500 Hz Network

High frequency gain at minimum, medium, and maximum. High frequency boost at maximum.

Other networks offer similar performance at their respective crossover frequencies. The 3160 network has a two position high frequency boost: IN (maximum) and OUT (minimum).



JBL, Incorporated, 8500 Balboa Boulevard, Northridge, California 91329.

JBL/harman international
65 078/IM3100/10-83/Printed in U.S.A.

3105
3110A, 3115A
3120A, 3160

FREQUENCY
DIVIDING
NETWORKS

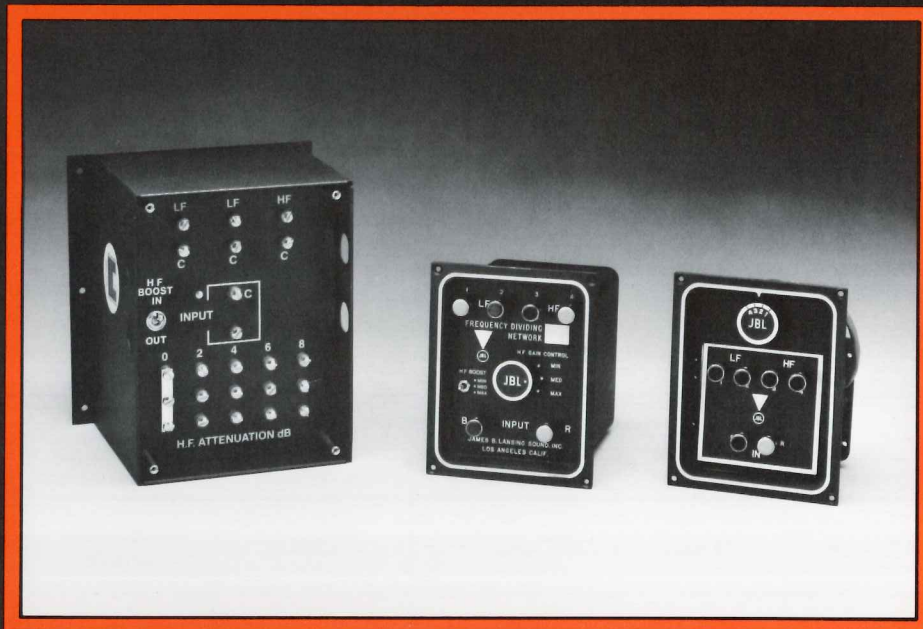

JBL professional frequency dividing networks are passive, high level devices designed to optimally blend JBL low and high frequency drivers. 12 dB/octave Butterworth filter shapes are assured by extensive use of impedance correcting conjugates and proper component values. Highest quality electronic components are used throughout – non-inductive, non-polarized capacitors having high AC current capacity built expressly for use in dividing networks, individually calibrated low-loss inductors, and oversize switches and resistors. High frequency shelving of networks crossing over below 7 kHz is accomplished with tapped autotransformers rather

than through resistive losses.

In addition to switchable high frequency attenuation, the 3110A, 3115A, and 3120A include a unique three-position high frequency equalization control that allows the user to adjust the response contour as well as optimize the crossover response for the new generation of constant directivity horns. The 3160 has a dual-position high frequency equalization control, and is a high power network designed primarily for theater, auditorium, or sound reinforcement applications. The 3105, 3110A, 3115A, and 3120A are for general applications.



3105, 3110A, 3115A, 3120A, 3160

ARCHITECTURAL SPECIFICATIONS:

The high level dividing network(s) shall be of the 12 dB per octave type with provisions for attenuating the high frequency driver in discrete steps. The circuitry shall consist of L-C sections with special provisions for minimizing the low frequency driver reactance. The inductors shall be wound on cores made of grain-oriented silicon steel laminations. In addition, networks crossing over below 7 kHz shall have a tapped inductor which allows autotransformer action to be obtained for

attenuation of the high frequency output.

Compensating parallel resistors shall be automatically selected for each tap so as to present a constant impedance to the input of the network when the high frequency driver is connected to the network. The dividing network (except 3105) shall include passive high frequency boost. The network shall be capable of handling 70 (300) (600) watts of program material power without overheating or clipping.

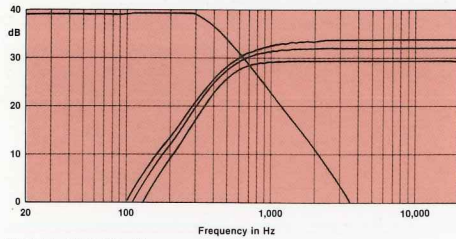

3115A 500 Hz Network

High frequency gain at minimum, medium, and maximum. High frequency boost at minimum.

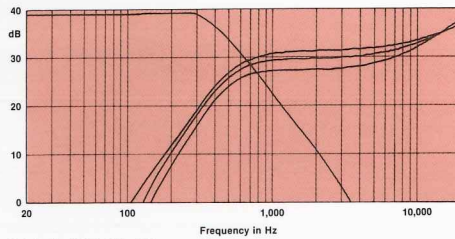

3115A 500 Hz Network.

High frequency gain at minimum, medium, and maximum. High frequency boost at medium.

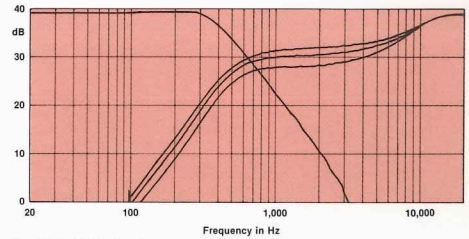

3115A 500 Hz Network

High frequency gain at minimum, medium, and maximum. High frequency boost at maximum.

Other networks offer similar performance at their respective crossover frequencies. The 3160 network has a two position high frequency boost: IN (maximum) and OUT (minimum).

SPECIFICATIONS:

Model	Crossover Frequency	Power Capacity		Impedance		High Frequency Gain (Attenuation)	High Frequency Boost
		Continuous Program ¹	Continuous Pink Noise ²	Low Frequency	High Frequency		
3105 ³	7000 Hz	70 watts	35 watts	16Ω	8Ω	Continuously variable	N/A
3110A	800 Hz	300 watts	150 watts	8Ω	16Ω	6-8-10 dB, Switch	Minimum, Medium, Maximum, Switch
3115A	500 Hz	300 watts	150 watts	8Ω	16Ω	6-8-10 dB, Switch	Minimum, Medium, Maximum, Switch
3120A	1250 Hz	300 watts	150 watts	8Ω	16Ω	6-8-10 dB, Switch	Minimum, Medium, Maximum, Switch
3160	500 Hz	600 watts	300 watts	4Ω	16Ω	0-2-4-6-8 dB, Strap	IN (Maximum) OUT (Minimum), Switch

¹ Continuous program power is defined as 3 dB greater than continuous pink noise power and is a conservative expression of the network's ability to handle normal speech and music program material.

² Continuous pink noise power rating is based on a test signal of filtered random noise conforming to international standard IEC 268-5 (pink noise with 12 dB per octave rolloff below 40 Hz and above 5,000 Hz with a peak to average ratio of 6 dB), two hours duration.

³ The 3105 is optimized for a single 2402H, 2404H, or 2405H tweeter installed in a system with any 16 ohm JBL compression driver.

JBL continually engages in research related to product improvement. New materials, production methods, and design refinements are introduced into existing products without notice as a routine expression of that philosophy. For this reason, any current JBL product may differ in some respect from its published description, but will always equal or exceed the original design specifications unless otherwise stated.

