

**I.F. = 455 KC.**

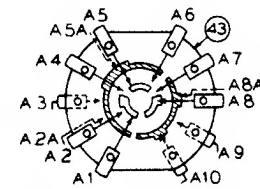

SWITCH SHOWN FROM REAR OF CHASSIS BOTTOM VIEW IN POSITION NO.1 B'DCAST. SHADED AREA INDICATES RING AT REAR OF SWITCH WAFER UNSHADED AREA INDICATES RING AT FRONT OF SWITCH WAFER.

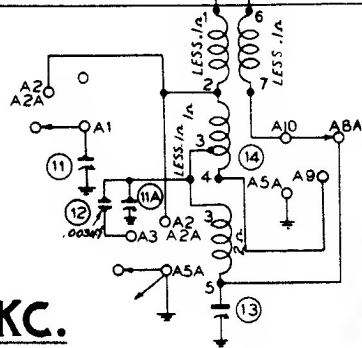
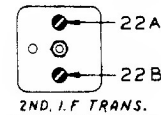
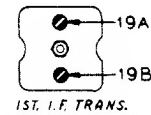
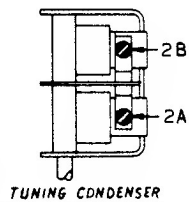
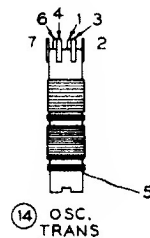
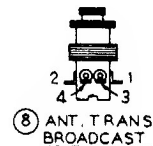
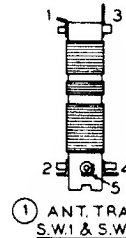
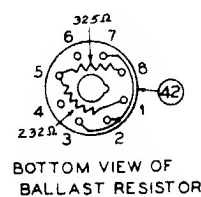
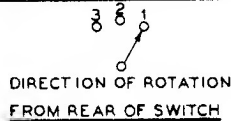

**PHILCO**

**SCHEMATIC DIAGRAM MODEL 41-705**