

Models 40X-30 and 40X-31 (Chassis No. RC405C & D)

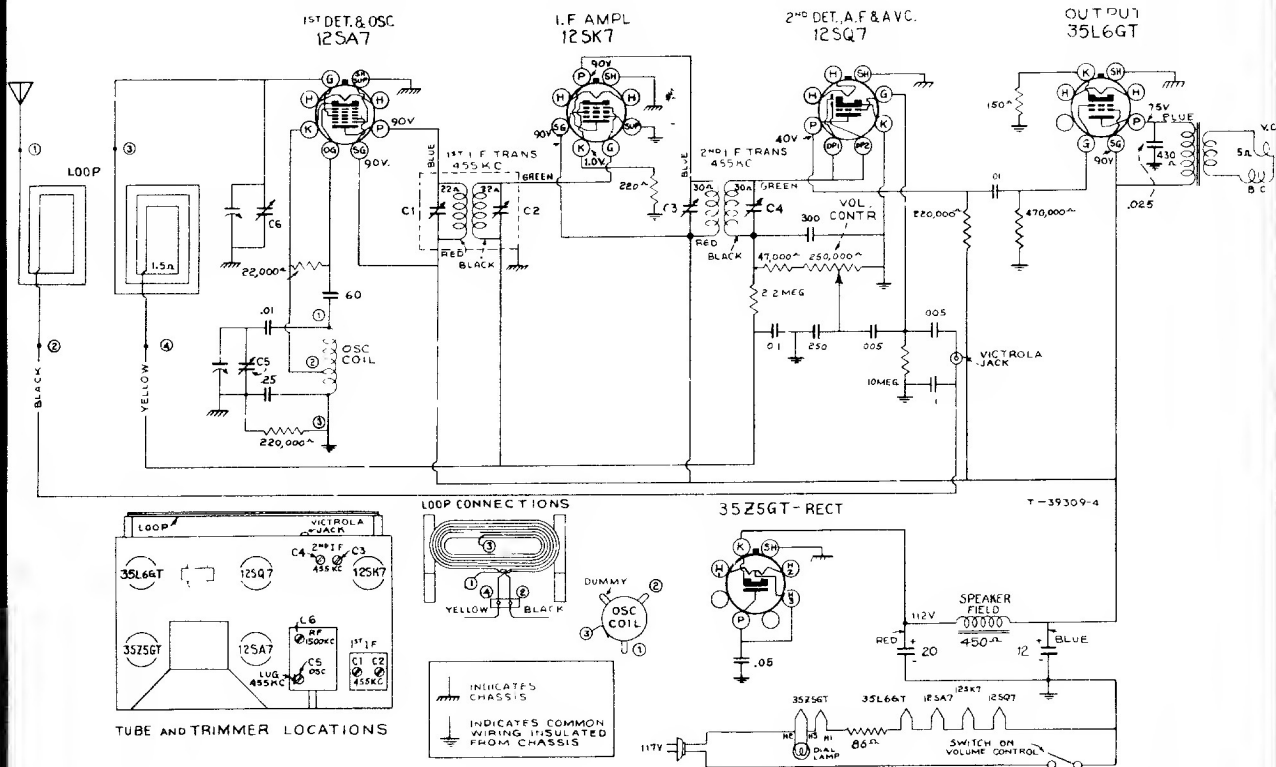

Output Meter Alignment.—Connect the meter across the voice coil, and turn the receiver volume control to maximum.

Test-Oscillator.—Connect the low side of the test-oscillator to the receiver chassis, through a .01 mfd. capacitor, and keep the output as low as possible.

Pre-setting Dial.—With gang condenser in full mesh, the pointer should be horizontal.

Antenna.—The set is equipped with a built-in loop antenna. If an outdoor antenna is used, it may be connected to the "ANT." terminal on rear of cabinet. It should not be longer than 100 feet, including lead-in. If it is longer, connect a 100 to 200 mmf. capacitor in series with the lead-in.

Power-Supply Polarity.—For operation on d-c, the power plug must be inserted in the outlet for correct polarity. If the set does not function, reverse the plug. On a-c, reversal of the plug may reduce hum.

Steps	Connect the high side of test-oscillator to—	Tune test-osc. to—	Turn radio dial to—	Adjust the following for max. peak output—
1	Tuning condenser stator (osc.) in series with .01 mfd.	455 kc	Quiet point at 1,600 kc end of dial	C1, C2, C3, C4 (1st and 2nd I-F transformers)
2	Antenna term. of ant. loop in series with 100 mmfd.	1,680 kc	Full clockwise (out of mesh)	C5 (oscillator)
3		1,500 kc	Resonance on 1,500 kc signal	C6 (antenna)

Precautionary Lead Dress

1. Dress 2nd I-F green lead close to chassis and under other parts.
2. Dress lead from gang condenser to grid of 12SA7 close to chassis and away from 12SQ7 socket.
3. Dress blue 1st I-F lead under volume control close to chassis.

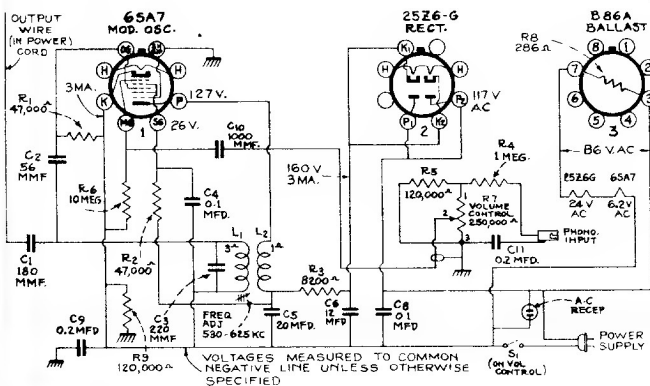

RCA
OSC-22
Wireless Oscillator

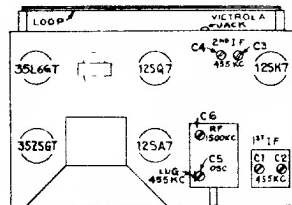
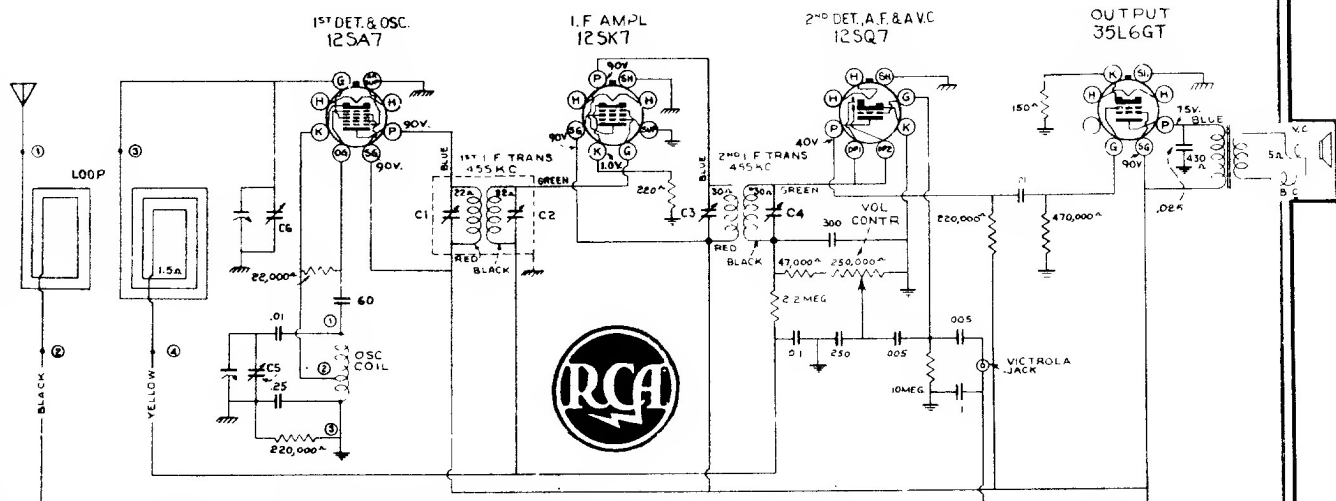

TUBE AND TRIMMER LOCATIONS

LOOP CONNECTIONS

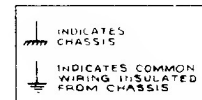
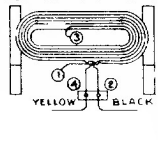

35Z5GT - RECT.

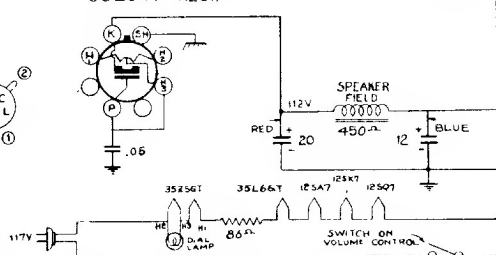

Models 40X-30 and 40X-31 (Chassis No. RC405C & D)